

MODEL NO. EL24-KFD010

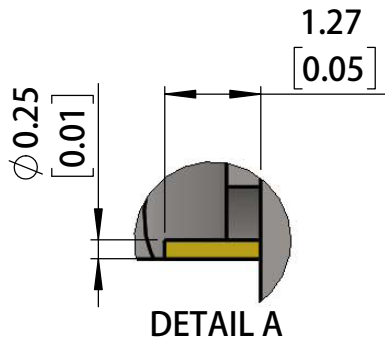
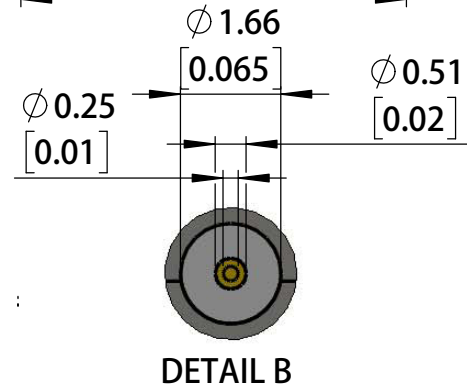
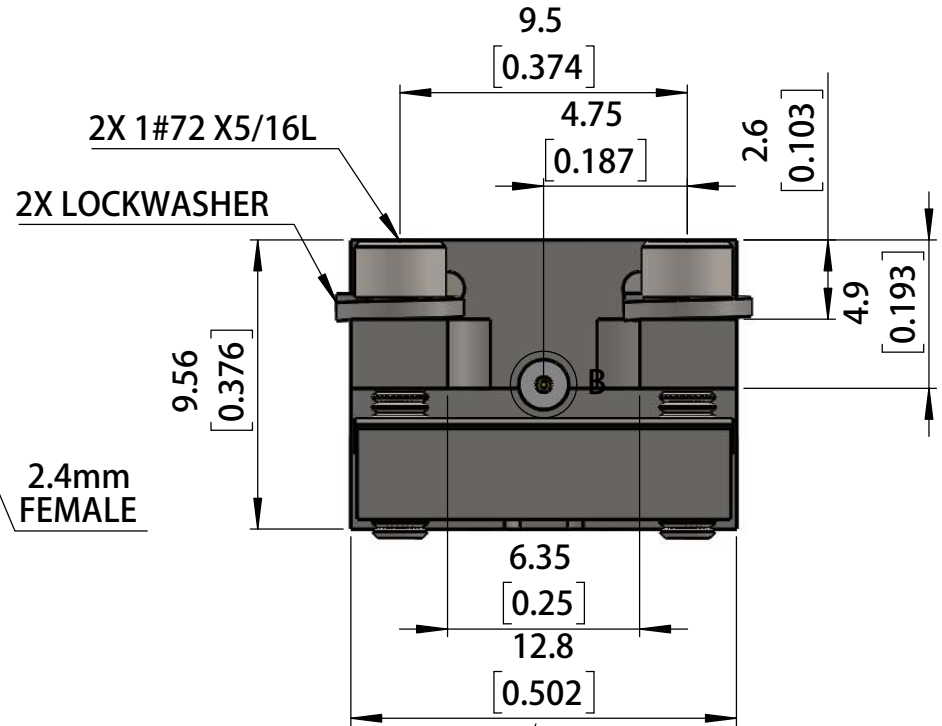
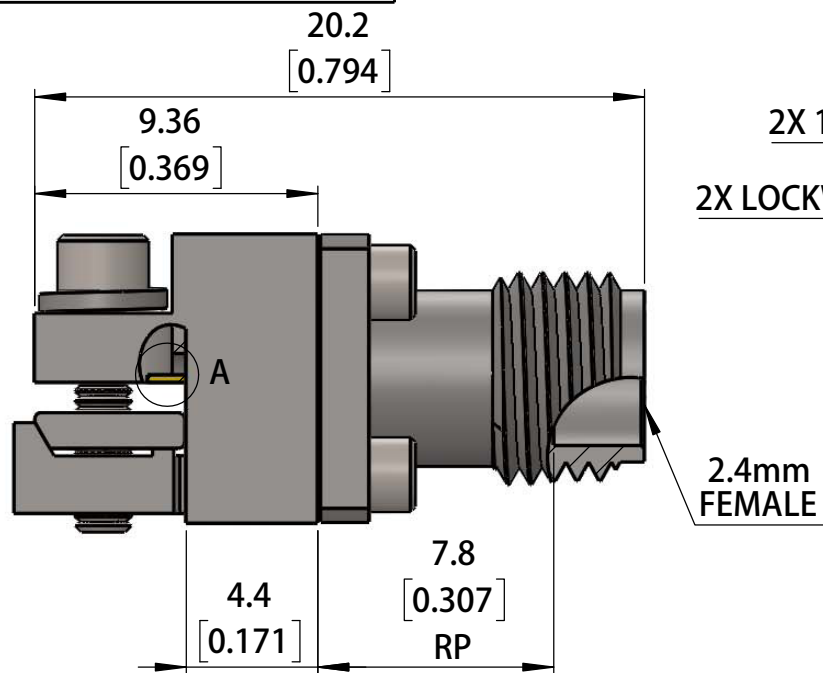

HOUSING:	SUS303
CONTACT:	BeCu C 17300 GOLD PLATE
BEAD:	PTFE
CAPTURE BEAD:	ULTEM
ITEM:	MATERIAL & FINISH
Frequency:	DC:50GHz
VSWR:	

REV.	RELEASE	APRVD:	DATE: 2020/2/12	TITLE: 2.4mm ENDLAUNCH CONNECTOR	
				MODEL NO. EL24-KFD010	
DRN BY:	DATE: 2020/2/12	SCALE: 4:1	SHEET: 1 OF 1	REV.	