

MODEL NO. EL18-KFD009

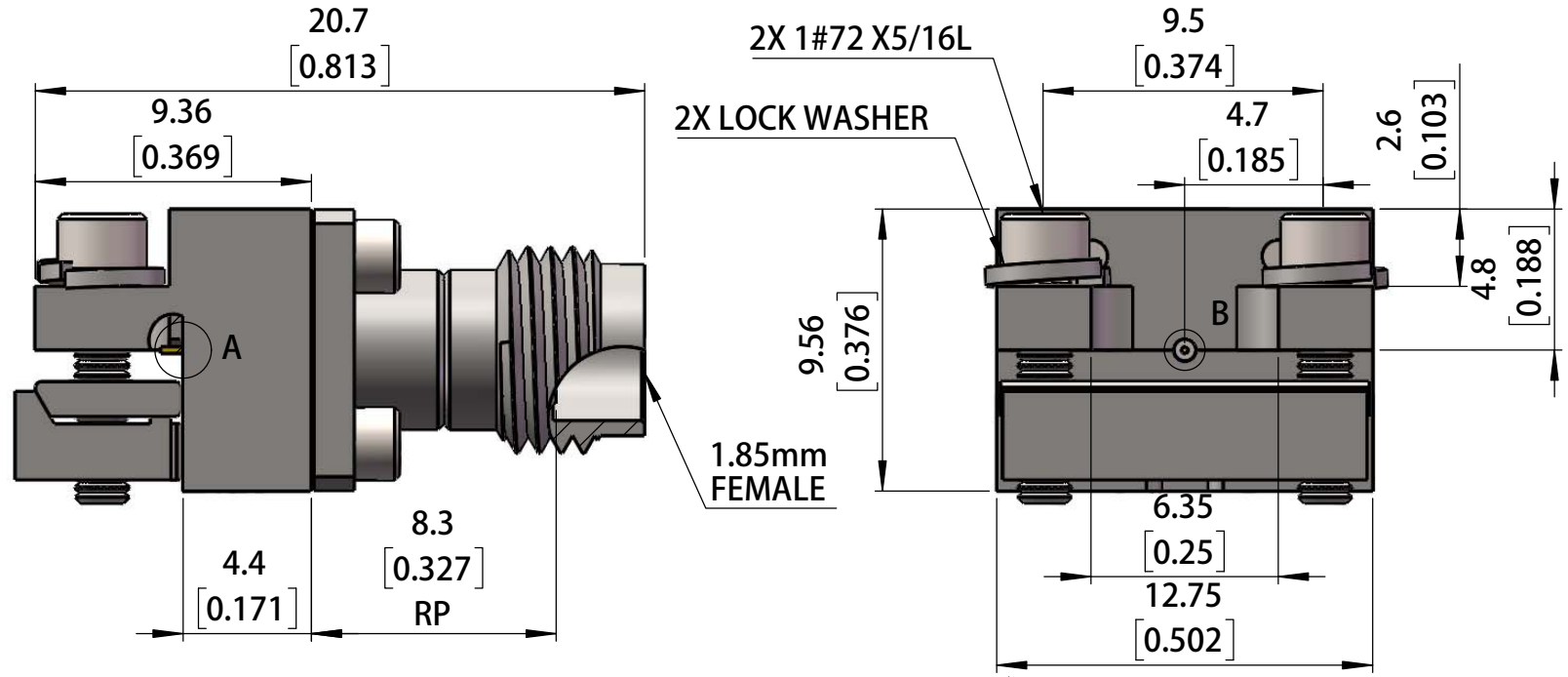

HOUSING:	SUS303
CONTACT:	BeCu C 17300 GOLD PLATE
BEAD:	PTFE
CAPTURE BEAD:	ULTEM
ITEM:	MATERIAL & FINISH
Frequency:	DC:67GHz
VSWR:	-

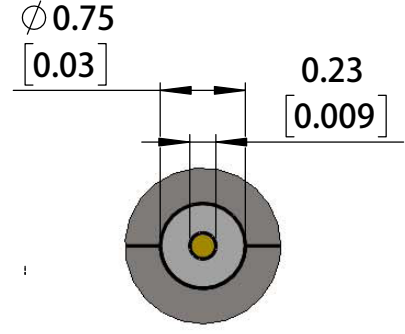
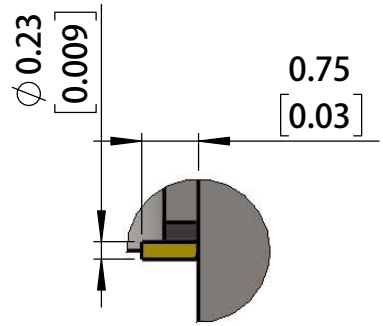

DETAIL A

DETAIL B

1. ALL DIMENSIONS ARE IN MILLIMETERS.  
 ALL ANGLES ARE IN DEGREES.  
 DIMENSIONS SHOWN IN BRACKETS [XXX] ARE IN INCHES.  
 NOTES: UNLESS OTHERWISE SPECIFIED.

REV. A	RELEASE REPLACES 1.0	APRVD: RedGreen	DATE: 2020/1/13	TITLE: 1.85mm ENDLAUNCH CONNECTOR	
				MODEL NO. EL18-KFD009	
DRN BY: SIG	DATE: 2020/1/13	SCALE: 4:1	SHEET: 1 OF 1	REV. A	