

MODEL NO. EL24-KFD009

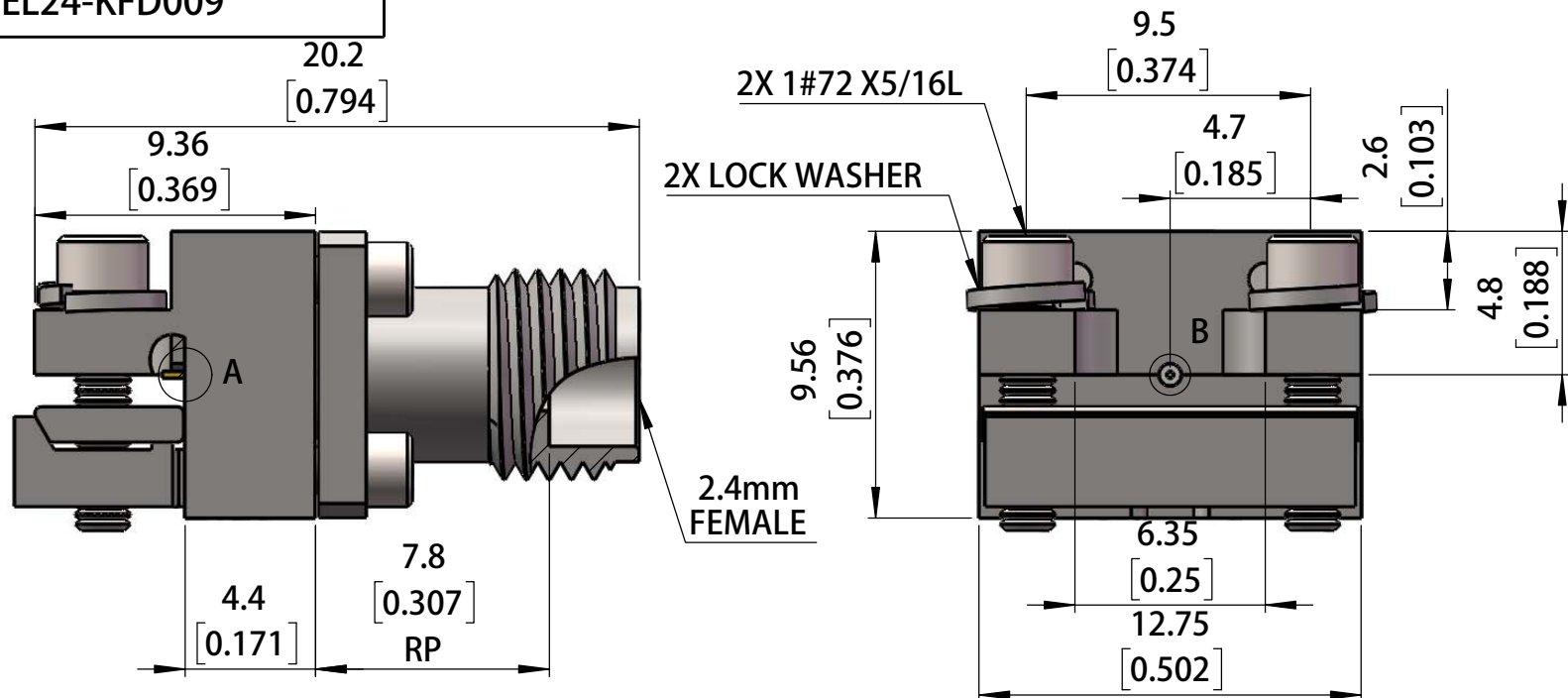

HOUSING:	SUS303
CONTACT:	BeCu C 17300 GOLD PLATE
BEAD:	PTFE
CAPTURE BEAD:	ULTEM
ITEM:	MATERIAL & FINISH
Frequency:	DC:50GHz
VSWR:	-

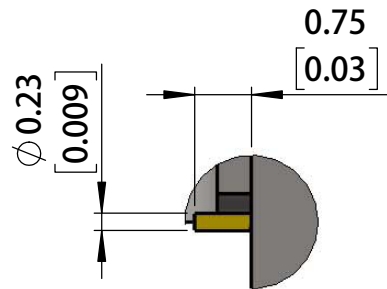

DETAIL A

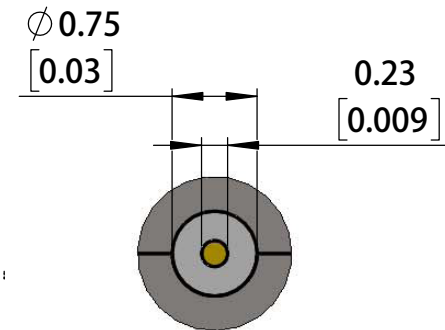

DETAIL B

1. ALL DIMENSIONS ARE IN MILLIMETERS.
 ALL ANGLES ARE IN DEGREES.
 DIMENSIONS SHOWN IN BRACKETS [XXX] ARE IN INCHES.
 NOTES: UNLESS OTHERWISE SPECIFIED.

REV. A	RELEASE REPLACES 1.0	APRVD: RedGreen	DATE: 2020/1/13	TITLE: 2.4mm ENDLAUNCH CONNECTOR	
				MODEL NO. EL24-KFD009	
DRN BY: SIG	DATE: 2020/1/13	SCALE: 4:1	SHEET: 1 OF 1	REV. A	