

标记 SIGN	版本 REV.	描述 DESCRIPTION	变更人 ORIGINATOR	日期 DATE	更改单号 REVISE NO.
/	/	新版发行 NEW EDITION	/	/	/

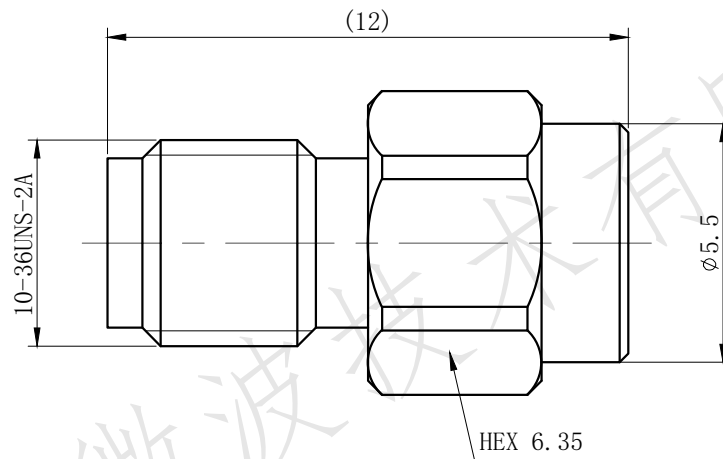

执行标准 Standard according to:GJB360B,MIL-STD-202

电气性能 Electrical Data:

- 特性阻抗 Impedance:50 Ω;
- 频率范围 Frequency range:DC-40GHz;
- 电压驻波比 VSWR:见附表 See table;
- 平均功率 Mean power:2W;

机械与环境性能 Mechanical Data And Environmental Data:

- 耐久性 Durability(matings):500 times;
- 温度范围 Temperature range:-55 to +125℃;

材料及表面处理 Material Data:

- 外导体 Outer Contact:不锈钢钝化 Stainless steel passivated;
- 内导体 Centre Contact:铍铜镀金 Beryllium copper gold-plated;
- 绝缘体 Insulator:PTFE;

SSMA-JR-2W40-02	≤1.30 (DC-40GHz)
SSMA-JR-2W40-01	≤1.25 (DC-40GHz)
P/N	VSWR



未注形位公差 GENERAL TOLERANCE OF FORM AND LOCATION		GB/T 1184-H							
未注尺寸公差 GENERAL DIMENSIONAL TOLERANCE		设计 DESIGN	Caogang 20210616					描述 DESCRIPTION	SSMA母头负载 SSMA Female Load
		校对 CHECK	Xuyan 20210616	名称 NAME	射频同轴负载 RF Coaxial Load	图号 DWG No.	-		
X. ±0.1	X° . ±1°	审核 AUDIT	Qzheng 20210616	视图 VIEW		产品型号 P/N	SSMA-KR-2W40-XX		
.X ±0.05	.X° ±0.5°	工艺 TECHNICS	LiLi 20210616	比例 SCALE	6:1	表面积SURFACE AREA (mm <sup>2</sup> )	-	版本 REV.	V1.0
.XX ±0.05	.XX° ±0.2°	标审 STANDARDIZE	WHlei 20210616	单位 UNIT	mm	重量 WEIGHT (g)	-	页码 SHEET OF	1/1
.XXX ±0.02	.XXX° ±0.1°	批准 APPROVE	TFsheng 20210616	图幅 SIZE	A4				

关键尺寸  
CRITICAL DIMENSION \*

F

E

D

C

B

A

F

E

D

C

B

A

1 2 3 4 5 6 7 8

1 2 3 4 5 6 7 8