

NOTES:UNLESSOTHERWISE SPECIFIED  
THIS IS A CAD GENERATED DRAWING,DO NOT REVISE MANUALLY

REVISION HISTORY					
ZONE	REV	DESCRIPTION	E.C.O.NO	DATE	APPROVED
	1	ENGINEERING RELEASE			

## LFC-2023

10.7 - 14.5 GHz 混频器 Frequency Mixer

### —电气技术参数 Electrical Specifications—

射频范围 RF Range:	10.7 - 14.5GHz
本振范围 LO Range:	15 - 21GHz
中频范围 IF Range:	0.8-3.0GHz
变频损耗 Conversion Loss:	10dB
输入1dB压缩功率IP1dB:	12dBm
直流电源电压DC Supply Voltage:	+12V
直流电源电流DC Supply Current:	1A
工作温度 Operation Temperature:	-20~+40 °C

### —机械技术参数 Mechanical Specifications—

RF 连接器 RF Interface:	SMA-F,前面板
LO 连接器 LO Interface:	SPI,后面板
IF 连接器 IF Interface:	SMA-F,前面板
直流电源连接器DC Power Interface:	同轴直流电源插座(5.5/2.5mm,后面板)
外部10MHz参考信号输入External Ref. Signal Interface:	SMA-F,后面板
重量 Weight :	200g

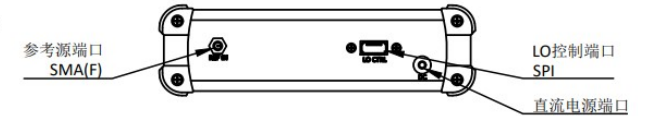
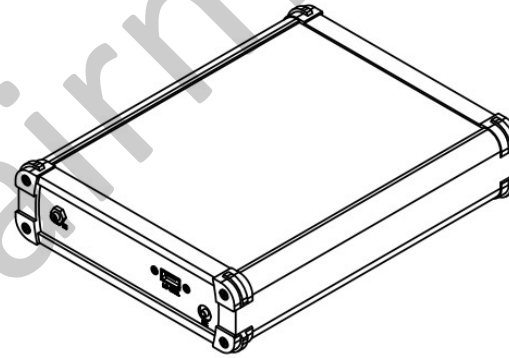
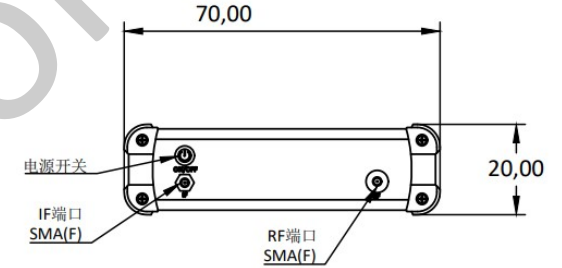
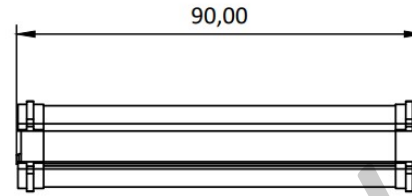

UNLESS OTHERWISE SPECIFIED DIMENSIONS ARE MILLIMETER TOLERANCES ARE: DECIMALS ANGLES FRACTIONS .XX±0.03 ±1' ±2/5 .XXX±0.012					P/N: LFC-2023	
	Approvals	DATE	10.7 - 14.5 GHz 混频器 Frequency Mixer			
HOLE DIAMETER .35 TO 3.20 3.21 TO 6.35 6.36 TO 12.70 12.71 TO 19.05 19.06 TO 25.40 25.41 TO 50.80	TOLERANCES +.05/- .02 +.10/- .03 +.15/- .03 +.20/- .03 +.25/- .03 +.30/- .03	DRWN	ENG	CHK	Q.A.	DATE
		SIZE	A3	CAGE NO	DWG NO.	REV
		SCALE	3:2	UNIT	mm	1
		SHEET 1 OF 1				