

NOTES: UNLESS OTHERWISE SPECIFIED
THIS IS A CAD GENERATED DRAWING, DO NOT REVISE MANUALLY

REVISION HISTORY					
ZONE	REV	DESCRIPTION	E.C.O.NO	DATE	APPROVED
	1	ENGINEERING RELEASE			

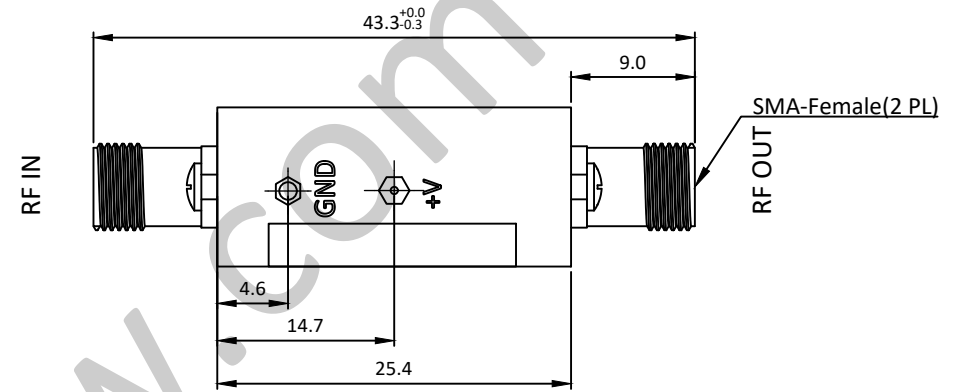
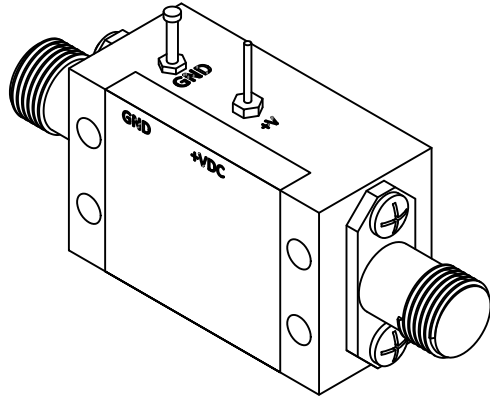

LAL-5076

5 - 10GHz 低噪声放大器 Low Noise Amplifier

—电气技术参数 Electrical Specifications—

频率范围 Frequency Range:	5 - 10GHz
增益 Gain:	19dB
增益平坦度 Gain Flatness:	/
噪声系数 Noise Figure:	2.0dB
输出 P _{1dB} Output P _{1dB} :	16dBm
输入驻波比 Input VSWR:	1.1:1
输出驻波比 Output VSWR:	1.3:1
直流偏置电压 DC Supply Voltage:	+5V
直流偏置电流 DC Supply Current:	78mA
工作温度 Operation Temperature:	-40 ~ +85°C
存储温度 Storage Temperature:	-55 ~ +125°C

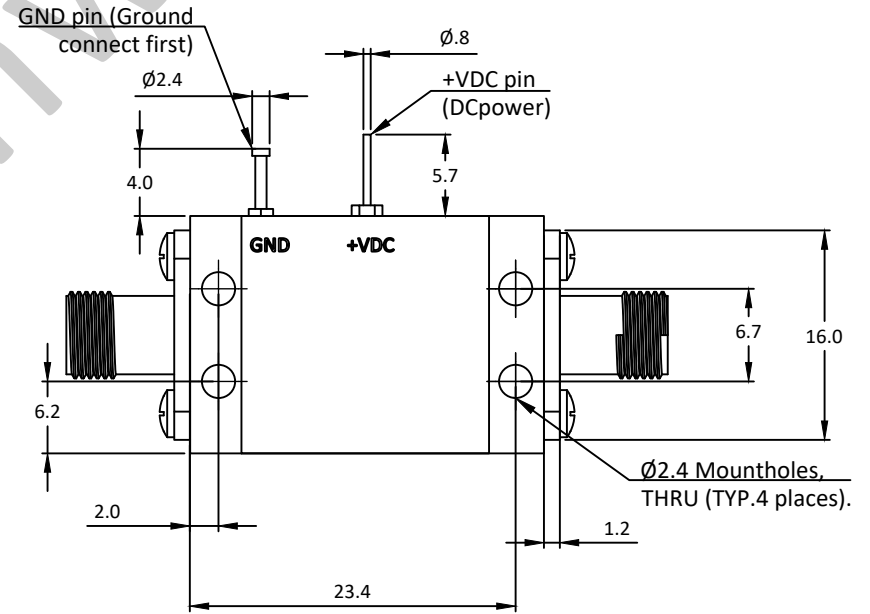
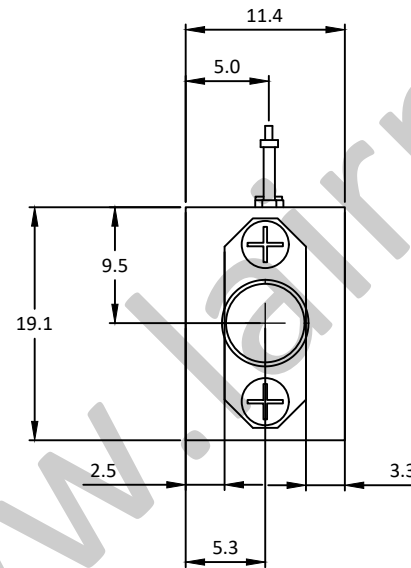

—机械技术参数 Mechanical Specification—

输入连接器 Input Interface:	SMA-F
输出连接器 Output Interface:	SMA-F
尺寸 Size (excluding connectors):	/
重量 Weight:	/

UNLESS OTHERWISE SPECIFIED
DIMENSIONS ARE MILLIMETER
TOLERANCES ARE:
DECIMALS ANGLES FRACTIONS
.XX±0.1 ±1' ±2/5
.XXX±0.03
.XXX±0.012

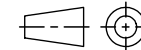

Approvals	DATE
DRWN	
ENG	
CHK	
Q.A.	



P/N: LAL-5076

5-10GHz 低噪声放大器 Low Noise Amplifier
增益 Gain 19dB, 噪声系数 NF 2.0dB

SIZE	CAGE NO	DWG NO.	REV
A3			1
SCALE	UNIT	SHEET 1 OF 1	
3:2	mm		

HOLE DIAMETER	TOLERANCES
.35 TO 3.20	+05/-02
3.21 TO 6.35	+10/-03
6.36 TO 12.70	+15/-03
12.71 TO 19.05	+20/-03
19.06 TO 25.40	+25/-03
25.41 TO 50.80	+30/-03