

NOTES: UNLESS OTHERWISE SPECIFIED
THIS IS A CAD GENERATED DRAWING, DO NOT REVISE MANUALLY

REVISION HISTORY					
ZONE	REV	DESCRIPTION	E.C.O.NO	DATE	APPROVED
	1	ENGINEERING RELEASE			

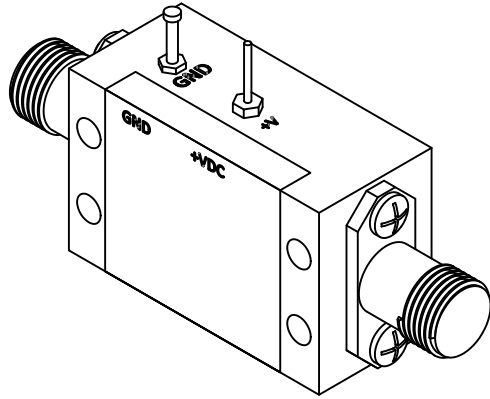

LAL-5045

1.8 - 3.8GHz 低噪声放大器 Low Noise Amplifier

—电气技术参数 Electrical Specifications—

频率范围 Frequency Range:	1.8 - 3.8GHz
增益 Gain:	18dB
增益平坦度 Gain Flatness:	/
噪声系数 Noise Figure:	0.8dB
输出 P _{1dB} Output P _{1dB} :	21dBm
输入驻波比 Input VSWR:	1.8:1
输出驻波比 Output VSWR:	1.6:1
直流偏置电压 DC Supply Voltage:	+9 ~ +15V
直流偏置电流 DC Supply Current:	110mA
工作温度 Operation Temperature:	-40 ~ +85°C
存储温度 Storage Temperature:	-55 ~ +125°C

—机械技术参数 Mechanical Specification—

输入连接器 Input Interface:	SMA-F
输出连接器 Output Interface:	SMA-F
尺寸 Size (excluding connectors):	/
重量 Weight:	/

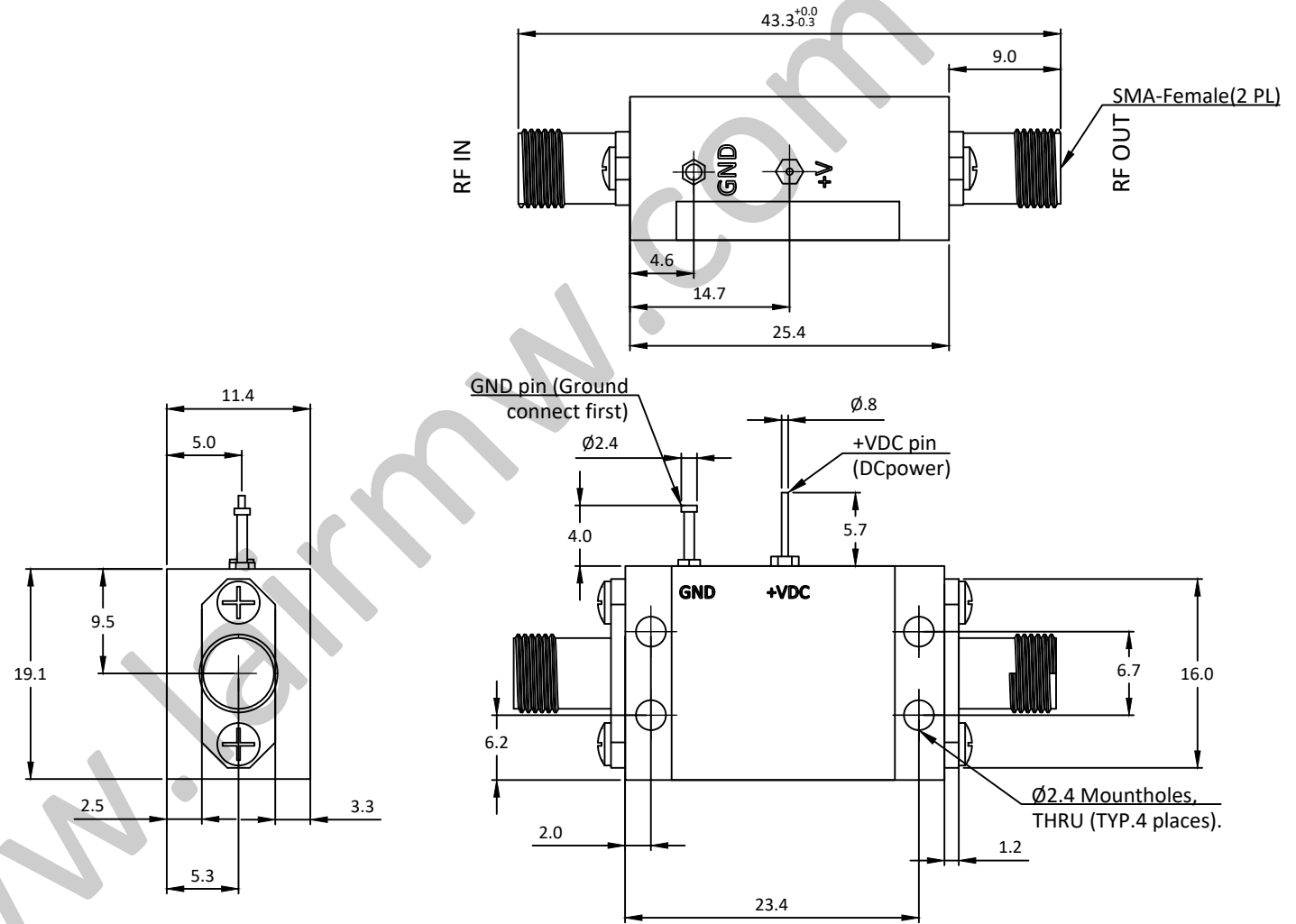

UNLESS OTHERWISE SPECIFIED
DIMENSIONS ARE MILLIMETER
TOLERANCES ARE:
DECIMALS ANGLES FRACTIONS
.XX±0.1 ±1' ±2/5
.XXX±0.03
.XXX±0.012

HOLE DIAMETER	TOLERANCES
.35 TO 3.20	+05/-02
3.21 TO 6.35	+10/-03
6.36 TO 12.70	+15/-03
12.71 TO 19.05	+20/-03
19.06 TO 25.40	+25/-03
25.41 TO 50.80	+30/-03

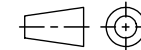

Approvals DATE

DRWN

ENG

CHK

Q.A.



www.lairmw.com sales@lairmw.com

P/N: LAL-5045

1.8-3.8GHz 低噪声放大器 Low Noise Amplifier
增益 Gain 18dB, 噪声系数 NF 0.8dB

SIZE	CAGE NO	DWG NO.	REV
A3			1
SCALE	UNIT	SHEET 1 OF 1	
3:2	mm		