

NOTES: UNLESS OTHERWISE SPECIFIED
THIS IS A CAD GENERATED DRAWING, DO NOT REVISE MANUALLY

REVISION HISTORY					
ZONE	REV	DESCRIPTION	E.C.O.NO	DATE	APPROVED
	1	ENGINEERING RELEASE			

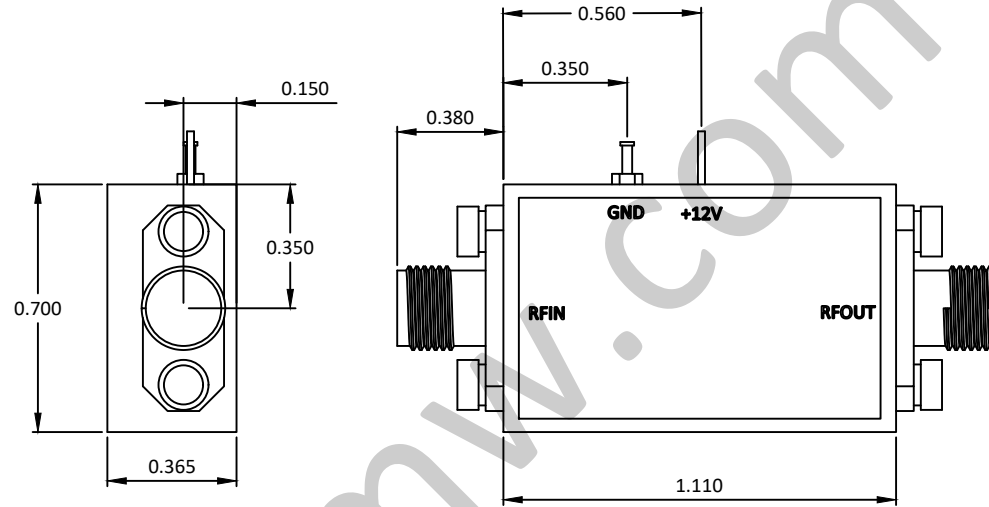
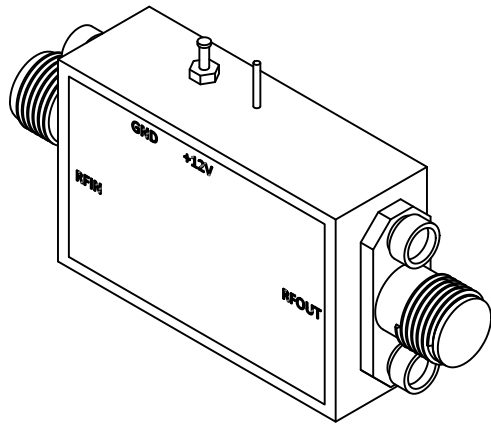

LAL-4069

12 - 18GHz 低噪声放大器 Low Noise Amplifier

—电气技术参数Electrical Specifications—

频率范围 Frequency Range:	12 - 18GHz
增益Gain:	30dB
增益平坦度Gain Flatness:	±1.5dB
噪声系数 Noise Figure:	2.2dB
输出 P_{1dB} Output P_{1dB} :	10dBm
输入驻波比Input VSWR:	2.2:1
输出驻波比Output VSWR:	2.2:1
直流偏置电压DC Supply Voltage:	+9 ~ +15V
直流偏置电流DC Supply Current:	215mA
工作温度Operation Temperature:	-40 ~ +85°C
存储温度Storage Temperature:	-55 ~ +125°C

—机械技术参数Mechanical Specification—

输入连接器Input Interface:	SMA-F
输出连接器Output Interface:	SMA-F
尺寸Size(excluding connectors):	/
重量Weight:	/

4X TAP #2-56 UNC-2B

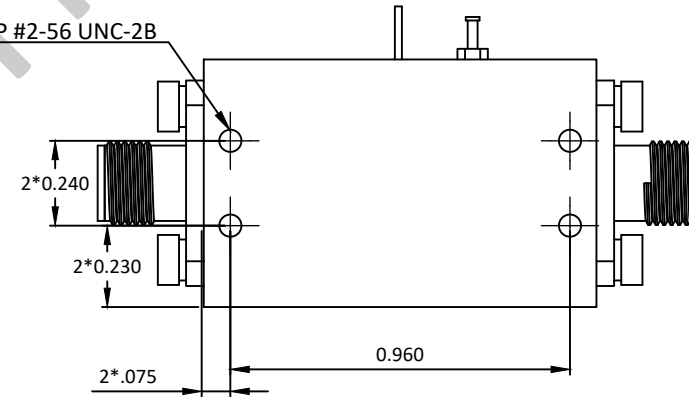

UNLESS OTHERWISE SPECIFIED
DIMENSIONS ARE MILLIMETER
TOLERANCES ARE:
DECIMALS ANGLES FRACTIONS
.XX±0.1 ±1' ±2/5
.XXX±0.012

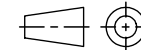

Approvals	DATE
DRWN	
ENG	
CHK	
Q.A.	



P/N: LAL-4069

12-18GHz 低噪声放大器 Low Noise Amplifier
增益 Gain 30dB, 噪声系数 NF 2.2dB

SIZE	A3	CAGE NO	DWG NO.	REV
SCALE	3:2	UNIT	mm	1
SHEET 1 OF 1				