

NOTES: UNLESS OTHERWISE SPECIFIED
THIS IS A CAD GENERATED DRAWING, DO NOT REVISE MANUALLY

REVISION HISTORY					
ZONE	REV	DESCRIPTION	E.C.O.NO	DATE	APPROVED
	1	ENGINEERING RELEASE			

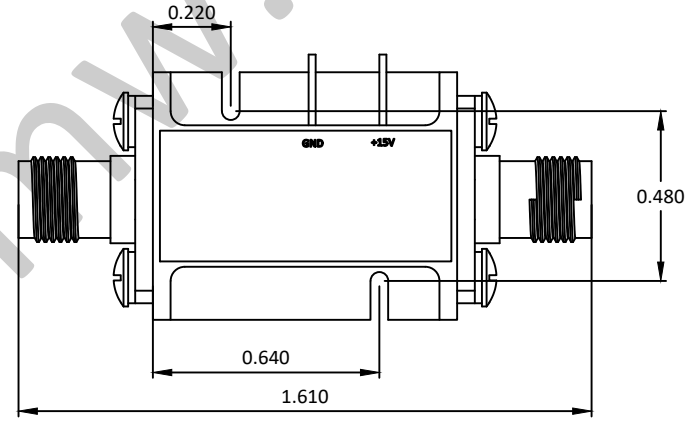
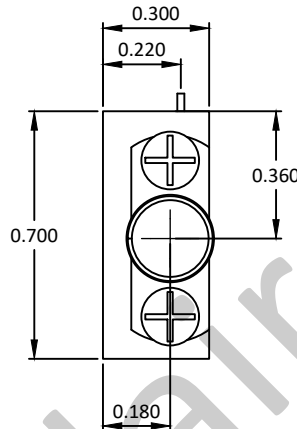
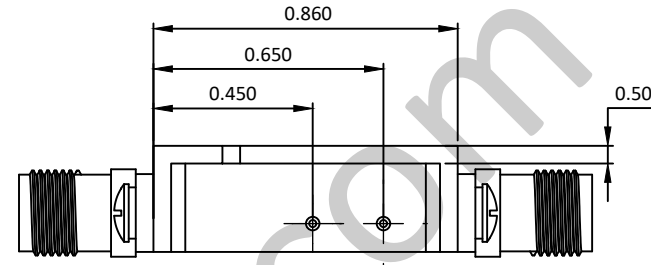
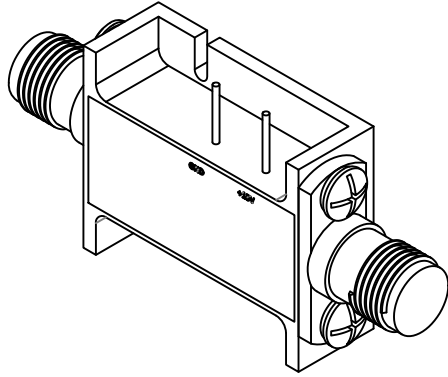

LAL-4058

8 - 12GHz 低噪声放大器 Low Noise Amplifier

—电气技术参数 Electrical Specifications—

频率范围 Frequency Range:	8 - 12GHz
增益 Gain:	40dB
增益平坦度 Gain Flatness:	±1.8dB
噪声系数 Noise Figure:	1.0dB
输出 P _{1dB} Output P _{1dB} :	20dBm
输入驻波比 Input VSWR:	2.0:1
输出驻波比 Output VSWR:	2.0:1
直流偏置电压 DC Supply Voltage:	+15V
直流偏置电流 DC Supply Current:	270mA
工作温度 Operation Temperature:	-40 ~ +85°C
存储温度 Storage Temperature:	-55 ~ +125°C

—机械技术参数 Mechanical Specification—

输入连接器 Input Interface:	SMA-F
输出连接器 Output Interface:	SMA-F
尺寸 Size (excluding connectors):	/
重量 Weight:	/

UNLESS OTHERWISE SPECIFIED
DIMENSIONS ARE MILLIMETER
TOLERANCES ARE:
DECIMALS ANGLES FRACTIONS
.X±0.1 ±1' ±2/5
.XX±0.03
.XXX±0.012

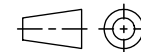

Approvals	DATE
DRWN	
ENG	
CHK	
Q.A.	



P/N: LAL-4058

8-12GHz 低噪声放大器 Low Noise Amplifier
增益 Gain 40dB, 噪声系数 NF 1.0dB

SIZE	CAGE NO	DWG NO.	REV
A3			1
SCALE	UNIT	SHEET 1 OF 1	
3:2	mm		