

NOTES: UNLESS OTHERWISE SPECIFIED
THIS IS A CAD GENERATED DRAWING, DO NOT REVISE MANUALLY

REVISION HISTORY					
ZONE	REV	DESCRIPTION	E.C.O.NO	DATE	APPROVED
	1	ENGINEERING RELEASE			

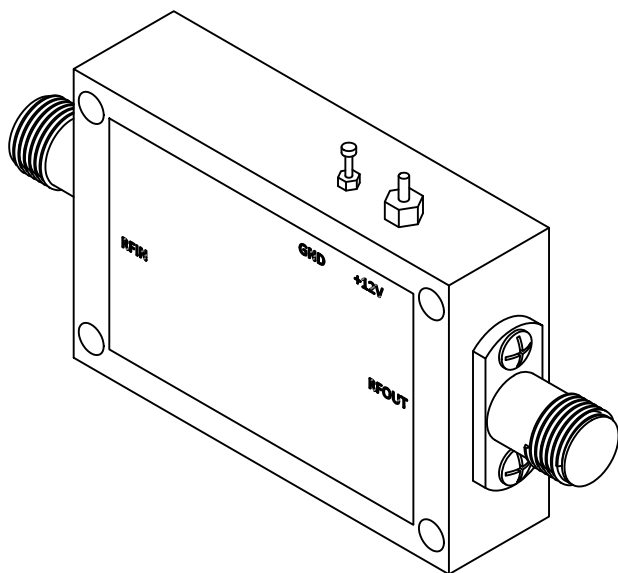

LAL-4010

0.1 - 18GHz 低噪声放大器 Low Noise Amplifier

—电气技术参数 Electrical Specifications—

频率范围 Frequency Range:	0.1 - 18GHz
增益 Gain:	14dB
增益平坦度 Gain Flatness:	±1.5dB
噪声系数 Noise Figure:	3.5dB
输出 P _{1dB} Output P _{1dB} :	12dBm
输入驻波比 Input VSWR:	2.0:1
输出驻波比 Output VSWR:	2.0:1
直流偏置电压 DC Supply Voltage:	+10 ~ +15V
直流偏置电流 DC Supply Current:	110mA
工作温度 Operation Temperature:	-40 ~ +85°C
存储温度 Storage Temperature:	-55 ~ +125°C

—机械技术参数 Mechanical Specification—

输入连接器 Input Interface:	SMA-F
输出连接器 Output Interface:	SMA-F
尺寸 Size (excluding connectors):	/
重量 Weight:	/

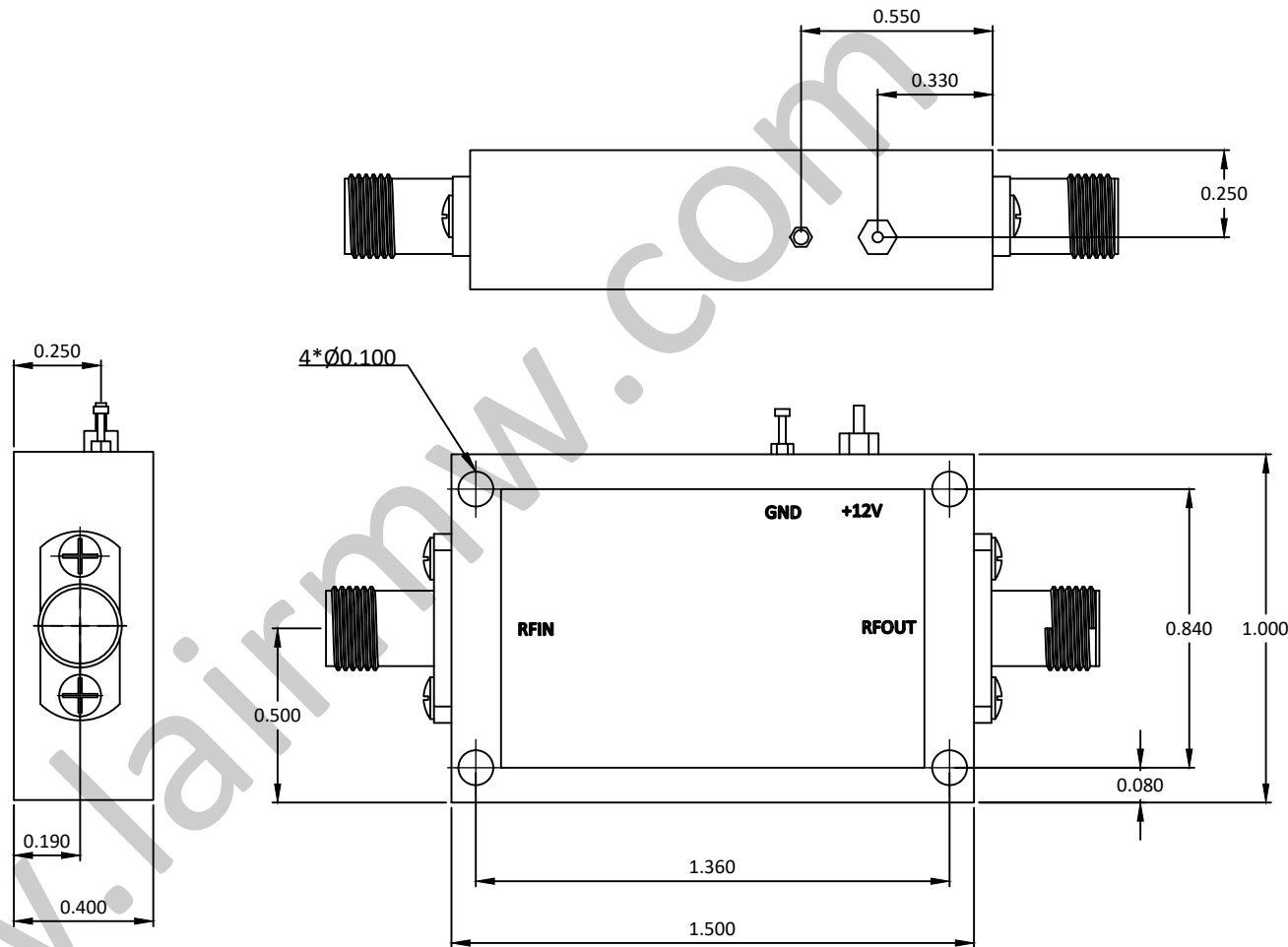

UNLESS OTHERWISE SPECIFIED
DIMENSIONS ARE MILLIMETER
TOLERANCES ARE:
DECIMALS ANGLES FRACTIONS
.XX±0.1 ±1' ±2/5
.XXX±0.03
.XXX±0.012

HOLE DIAMETER	TOLERANCES
.35 TO 3.20	+.05/-0.2
3.21 TO 6.35	+.10/-0.3
6.36 TO 12.70	+.15/-0.3
12.71 TO 19.05	+.20/-0.3
19.06 TO 25.40	+.25/-0.3
25.41 TO 50.80	+.30/-0.3

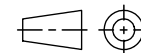

Approvals

DATE

DRWN

ENG

CHK

Q.A.



www.lairmw.com sales@lairmw.com

P/N: LAL-4010

0.1-18GHz 低噪声放大器 Low Noise Amplifier
增益 Gain 14dB, 噪声系数 NF 3.5dB

SIZE	CAGE NO	DWG NO.	REV
A3			1
SCALE	UNIT	SHEET 1 OF 1	
3:2	mm		