

NOTES: UNLESS OTHERWISE SPECIFIED
THIS IS A CAD GENERATED DRAWING, DO NOT REVISE MANUALLY

REVISION HISTORY					
ZONE	REV	DESCRIPTION	E.C.O.NO	DATE	APPROVED
	1	ENGINEERING RELEASE			

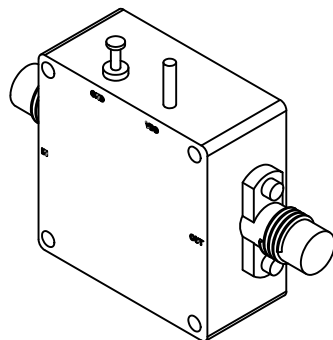

LAL-3071

40 - 60GHz 低噪声放大器 Low Noise Amplifier

—电气技术参数 Electrical Specifications—

频率范围 Frequency Range:	40 - 60GHz
增益 Gain:	38dB
增益平坦度 Gain Flatness:	/
噪声系数 Noise Figure:	3.0dB
输出 P_{1dB} Output P_{1dB} :	2dBm
输入驻波比 Input VSWR:	7dB
输出驻波比 Output VSWR:	7dB
直流偏置电压 DC Supply Voltage:	+5V
直流偏置电流 DC Supply Current:	30mA
工作温度 Operation Temperature:	-40 ~ +85°C
存储温度 Storage Temperature:	-55 ~ +125°C

—机械技术参数 Mechanical Specification—

输入连接器 Input Interface:	1.85mm-F
输出连接器 Output Interface:	1.85mm-F
尺寸 Size (excluding connectors):	/
重量 Weight:	/

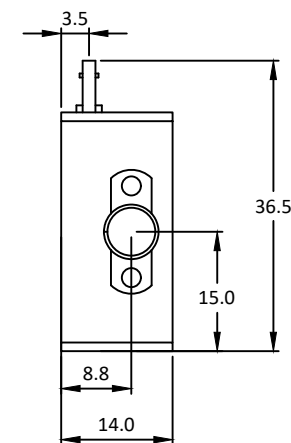
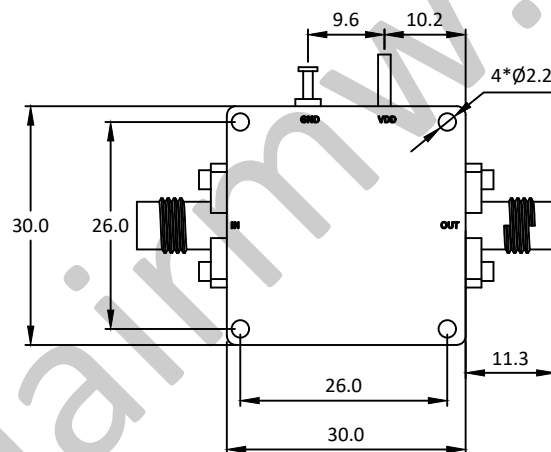

UNLESS OTHERWISE SPECIFIED
DIMENSIONS ARE MILLIMETER
TOLERANCES ARE:
DECIMALS ANGLES FRACTIONS
.XX±0.1 ±1° ±2/5
.XXX±0.012

HOLE DIAMETER	TOLERANCES
.35 TO 3.20	+0.05/-0.02
3.21 TO 6.35	+0.10/-0.03
6.36 TO 12.70	+0.15/-0.03
12.71 TO 19.05	+0.20/-0.03
19.06 TO 25.40	+0.25/-0.03
25.41 TO 50.80	+0.30/-0.03

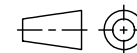

Approvals

DATE

DRWN

ENG

CHK

Q.A.



www.lairmw.com sales@lairmw.com

P/N: LAL-3071

40-60GHz 低噪声放大器 Low Noise Amplifier
增益 Gain 38dB, 噪声系数 NF 3.0dB

SIZE	CAGE NO	DWG NO.	REV
A3			1
SCALE 3:2	UNIT mm	SHEET 1 OF 1	