

NOTES: UNLESS OTHERWISE SPECIFIED
THIS IS A CAD GENERATED DRAWING, DO NOT REVISE MANUALLY

REVISION HISTORY					
ZONE	REV	DESCRIPTION	E.C.O.NO	DATE	APPROVED
	1	ENGINEERING RELEASE			

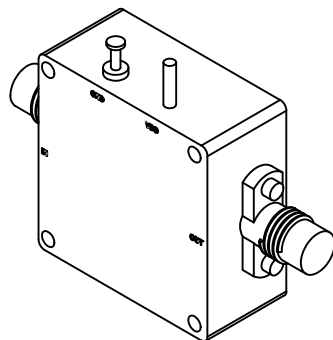

LAL-3018

4 - 8GHz 低噪声放大器 Low Noise Amplifier

—电气技术参数 Electrical Specifications—

频率范围 Frequency Range:	4 - 8GHz
增益 Gain:	50dB
增益平坦度 Gain Flatness:	±1.5dB
噪声系数 Noise Figure:	1.0dB
输出 P _{1dB} Output P _{1dB} :	10dBm
输入驻波比 Input VSWR:	10dB
输出驻波比 Output VSWR:	10dB
直流偏置电压 DC Supply Voltage:	+5V
直流偏置电流 DC Supply Current:	100mA
工作温度 Operation Temperature:	-40~+85°C
存储温度 Storage Temperature:	-55~+125°C

—机械技术参数 Mechanical Specification—

输入连接器 Input Interface:	SMA-F
输出连接器 Output Interface:	SMA-F
尺寸 Size (excluding connectors):	/
重量 Weight:	/

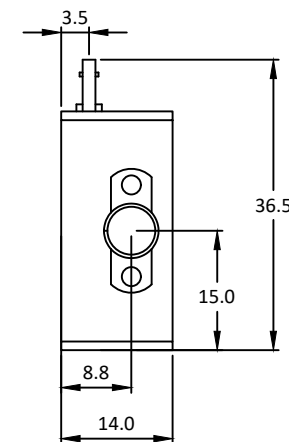
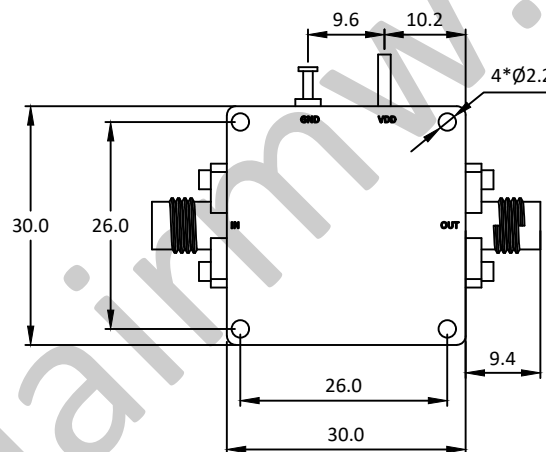

UNLESS OTHERWISE SPECIFIED DIMENSIONS ARE MILLIMETER TOLERANCES ARE: DECIMALS ANGLES FRACTIONS .XX±0.1 ±1° ±2/5 .XXX±0.012			莱尔微波 www.lairmw.com sales@lairmw.com	P/N: LAL-3018	
	Approvals	DATE		4-8GHz 低噪声放大器 Low Noise Amplifier 增益 Gain 50dB, 噪声系数 NF 1.0dB	
HOLE DIAMETER .35 TO 3.20 3.21 TO 6.35 6.36 TO 12.70 12.71 TO 19.05 19.06 TO 25.40 25.41 TO 50.80	TOLERANCES +.05/-02 +.10/-03 +.15/-03 +.20/-03 +.25/-03 +.30/-03	DRWN ENG CHK Q.A.	SIZE A3	CAGE NO	DWG NO. REV 1
			SCALE 3:2	UNIT mm	SHEET 1 OF 1