

NOTES: UNLESS OTHERWISE SPECIFIED
THIS IS A CAD GENERATED DRAWING, DO NOT REVISE MANUALLY

REVISION HISTORY					
ZONE	REV	DESCRIPTION	E.C.O.NO	DATE	APPROVED
	1	ENGINEERING RELEASE			

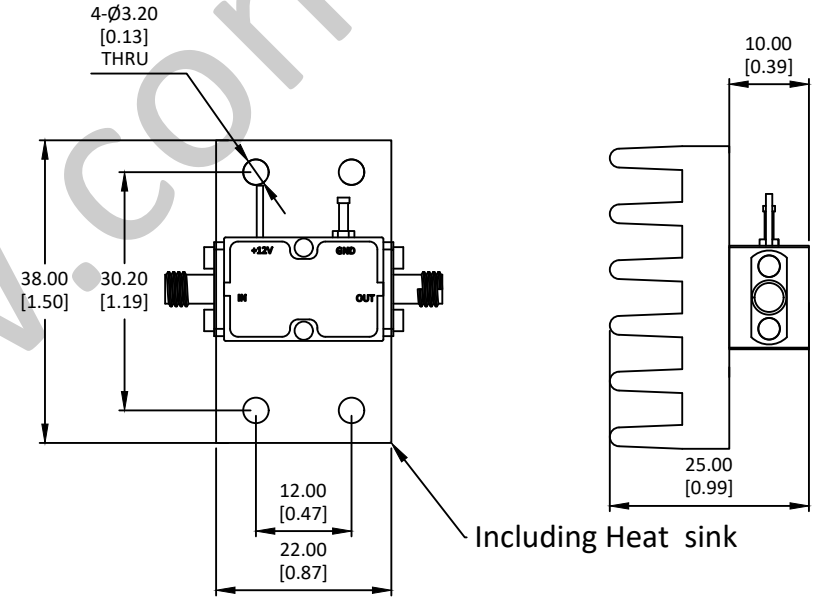

LAL-1116

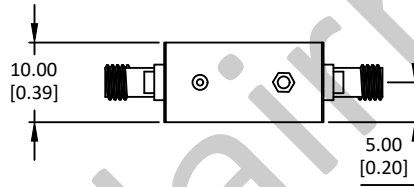
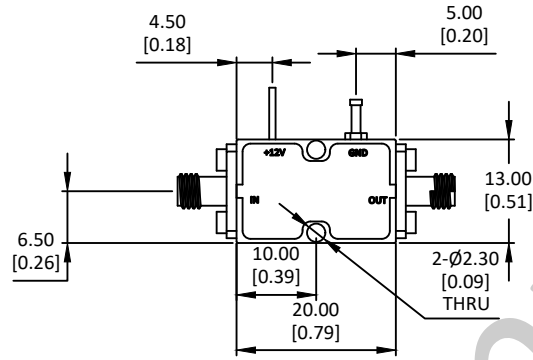
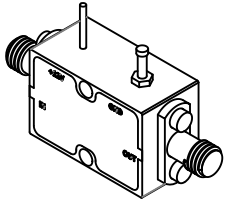

6~18GHz 低噪声放大器 Low Noise Amplifier

—电气技术参数 Electrical Specifications—

频率范围 Frequency Range:	6 - 18GHz
增益 Gain:	42dB
增益平坦度 Gain Flatness:	/
噪声系数 Noise Figure:	1.5dB
输出 P_{1dB} Output P_{1dB} :	17dBm
输入驻波比 Input VSWR:	1.2:1
输出驻波比 Output VSWR:	1.2:1
直流偏置电压 DC Supply Voltage:	+12V
直流偏置电流 DC Supply Current:	100mA
工作温度 Operation Temperature:	-40~+85°C
存储温度 Storage Temperature:	-50~+105°C

—机械技术参数 Mechanical Specification—

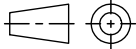
输入连接器 Input Interface:	SMA-F
输出连接器 Output Interface:	SMA-F
尺寸 Size (excluding connectors):	/
重量 Weight:	/

UNLESS OTHERWISE SPECIFIED DIMENSIONS ARE MILLIMETER TOLERANCES ARE: DECIMALS ANGLES FRACTIONS .XX±0.03 ±1' ±2/5 .XXX±0.012					P/N: LAL-1116	
			www.lairmw.com sales@lairmw.com			
HOLE DIAMETER .35 TO 3.20 3.21 TO 6.35 6.36 TO 12.70 12.71 TO 19.05 19.06 TO 25.40 25.41 TO 50.80	TOLERANCES +.05/-02 +.10/-03 +.15/-03 +.20/-03 +.25/-03 +.30/-03	Approvals	DATE	6-18GHz 低噪声放大器 Low Noise Amplifier 增益 Gain 42dB, 噪声系数 NF 1.5dB		
DRWN	ENG	CHK	Q.A.	SIZE A3	CAGE NO	DWG NO.
				SCALE 3:2	UNIT mm	REV 1
				SHEET 1 OF 1		