

NOTES: UNLESS OTHERWISE SPECIFIED
THIS IS A CAD GENERATED DRAWING, DO NOT REVISE MANUALLY

REVISION HISTORY					
ZONE	REV	DESCRIPTION	E.C.O.NO	DATE	APPROVED
	1	ENGINEERING RELEASE			

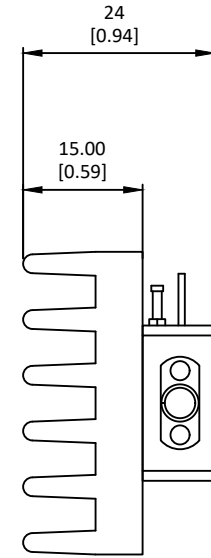
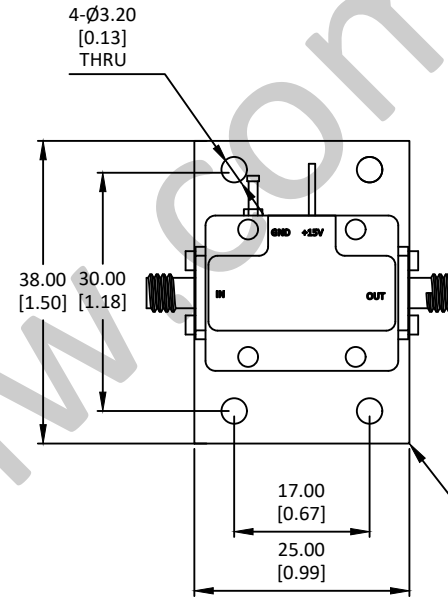
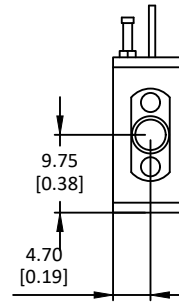
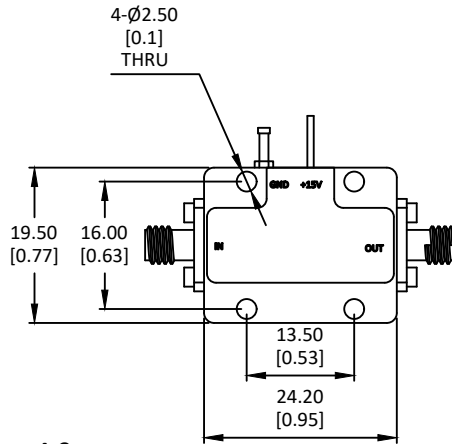
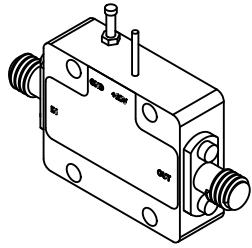

Including Heat sink

LAL-1045

8~12GHz 低噪声放大器 Low Noise Amplifier

—电气技术参数 Electrical Specifications—

频率范围 Frequency Range:

增益 Gain:

增益平坦度 Gain Flatness:

噪声系数 Noise Figure:

输出 P_{1dB} Output P_{1dB} :

输入驻波比 Input VSWR:

输出驻波比 Output VSWR:

直流偏置电压 DC Supply Voltage:

直流偏置电流 DC Supply Current:

工作温度 Operation Temperature:

存储温度 Storage Temperature:

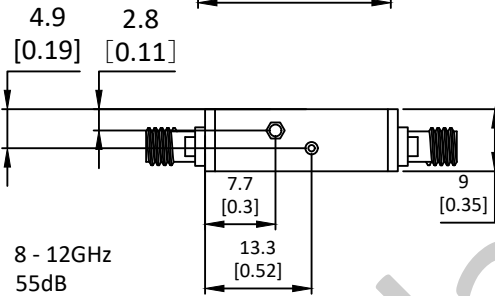

8 - 12GHz

55dB

/

1.0dB

17dBm

1.2:1

1.2:1

+15V

165mA

-40~+85°C

-50~+105°C

—机械技术参数 Mechanical Specification—

输入连接器 Input Interface:

输出连接器 Output Interface:

尺寸 Size (excluding connectors):

重量 Weight:

2.92mm-F

2.92mm-F

/

/

UNLESS OTHERWISE SPECIFIED
DIMENSIONS ARE MILLIMETER
TOLERANCES ARE:
DECIMALS ANGLES FRACTIONS
.XX±0.03 ±1° ±2/5
.XXX±0.012

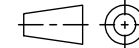

Approvals

DATE

DRWN

ENG

CHK

Q.A.



www.lairmw.com sales@lairmw.com

P/N: LAL-1045

8-12GHz 低噪声放大器 Low Noise Amplifier
增益 Gain 55dB, 噪声系数 NF 1.0dB

SIZE

A3

CAGE NO

UNIT

mm

DWG NO.

SHEET 1 OF 1

REV

1

HOLE DIAMETER

.35 TO 3.20

3.21 TO 6.35

6.36 TO 12.70

12.71 TO 19.05

19.06 TO 25.40

25.41 TO 50.80

TOLERANCES

+.05/-02

+.10/-03

+.15/-03

+.20/-03

+.25/-03

+.30/-03